

Importation & Distribution Electronic Components

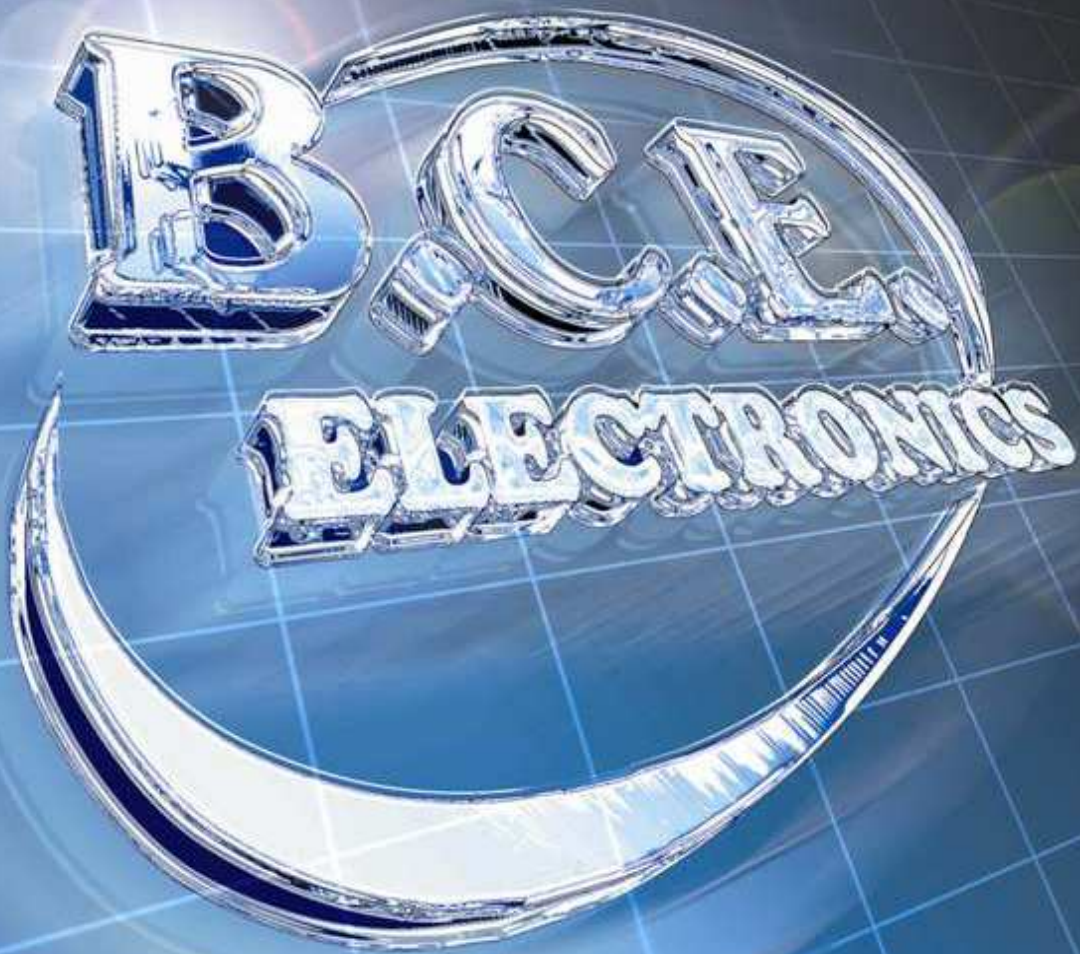

Product Overview



# LINECARD



**Waterproof Solutions:** Circular Conn.s, Power Conn.s, M Series Conn.s, Junction Box, USB, IEEE1394, D-SUB, DVI, RJ Conn.s, SSL Conn.s, LED Indicator, HDMI, Fiber Optic, NMEA 2000 Conn.s, PV AC Conn.s / T-Junction, Cable Joiner, FICX Conn.s, Cable Gland, Vent, RBL Conn.rs, X-Lok & HS-Lok Conn.s, Cable Assembly, Custom Prod.s



**Waterproof Solutions:** M Series Sensor Conn.s: M5, M8, M12, M16, M17, M23, M40 Conn.s, 7/8" Conn.s, Junction Box, Splitter, Valve Conn.s, **Heavy Duty Connectors**, Industrial Network Conn.s, DeviceNet, Ethernet, EtherCAT, Profinet, Industrial Relay, Inductive & Capacitive Sensors, Cables, Cable Assemblies, Customized Products



**Waterproof Solutions:** Circular Connectors, M Series Connectors, NMEA 2000 Connectors, USB Connectors, RJ45 Connectors, HDMI Connectors, BNC Connectors, Hybrid Connectors, Cable Assemblies, CNC & Stamping Parts, Turn-Key Solutions, Customized Products



**Waterproof Circular Connectors:** SF Series-IP67 shielded push-pull, SA Series-IP67 shielded push-pull, ST12-IP67 shielded, SP Series-IP68, SY Series-IP67, WA22-IP67, WAC3 Series IP65, WP Series, WL Series, WD Series, WS Series, WF Series, WY Series.



**Fine Pitch** (0,25-0,4-0,5-0,635-1-1,27, 2,54mm) conn.s, **Half Pitch** (200-up) conn.s (86-87-88-89 series), **B to B** Conn.s, **Micro Coaxial** Conn.s, IDC conn.s for Micro Coaxial Cable, Crimp FA & FAS Series, **Floating** conn.s, Interface conn.s, Battery conn.s, Cable Assembly.

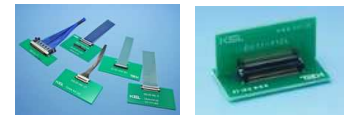

**High Speed Connectors**, **CXP Series**, **QSFP Series**, **SFP+ Series**, **SFP Enhance Series**, **SFP Series**, **XFP Series**, **InfiniBand Series**, **CX4 Series**, **PCI-E Series**, **Mini SAS Series**, **Micro D Series**, **VHDCI Series**, **SCSI II / III Series**, Hoods, Special Hoods, Cable Assemblies.



**Battery connectors**, **Spring Loaded connectors**, **Pogo Pin connectors**, **Spring Pin connectors**, B to B, W to B & W to W connectors, PAD, Memory Card, C.F. Card, D-SUB, Mini USB & Micro USB, RJ Jack, Machine Pin Sockets, SATA, USB, Custom Products.



**Pogo Pin Connectors**, Spring Loaded Connectors, EV Crown Spring, Magnetic Solutions, Testing and Burn-in Solutions, ATE Connecting Solutions, Fine Pitch Connector Test, High Current Solutions, High Frequency Solutions, Customized Products.

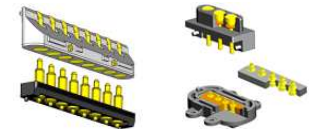

**Turn-Key Solutions**, USB Hub USB Docking, Wireless Charging, Waterproof Conn.s, Automotive Conn.s, Medical Conn.s, OBD2 Solution, USCAR Conn.s, DisplayPort Dongle, DisplayPort Adaptor, Pogo Magnetic, Device Charge Cable, **Cable Ass.y Customized.**

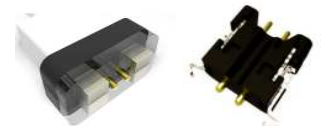

**Custom Cable Assemblies** : Automotive Cable, Waterproof Cable, USB & IEEE 1394, Power Cord, HDMI & DVI, VGA & KVM, SCSI Cable, FPC / FFC Cable, Micro Match Cable, SATA Cable, RF Cable, LCD Telecom, IP Camera Cable Assembly. **Connectors:** B to B, Header, W to B, IDC, USB & IEEE 1394, HDMI, DVI, SCSI, D-SUB & Hood, FPC-FFC, SATA, Mini Din, DC Power, RCA / RJ45 Jack, Custom.

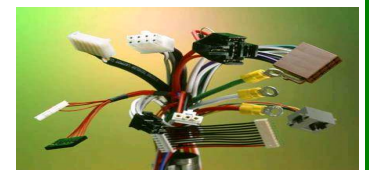

**Hoods**, Unshielded Plastic Hoods, Shielded, Die cast Hoods, Shielded Metal and Plastic Hoods, Multi Entry Hoods, Shielded Hoods for Slide, Lock Mount, Adapters, Special Hoods, Accessories, D-SUB connectors, Tooling, Customized Products.







**Crystal Units MHz & KHz range, Quartz Crystal Oscillators**  
 HCMOS/LVPECL/LVDS/HCSL – SMD & Pin Type, Tuning Fork Crystal,  
 Programmable Oscillators, **VCXO** (Voltage Controlled Xtal  
 Oscillators), **VC-TCXO** (Voltage Controlled Temperature  
 Compensated Xtal Oscillators), **VCXO – TCXO – (VC)TCXO**-Clipped  
 Sine-SMD, **OCXO** (Oven Controlled Xtal Oscillators), **VCXO-PECL-**  
 SMD, **LVDS-SMD**, **MEMS Oscillators**, Customized Products.

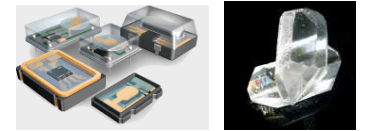

**Quartz Crystal, Crystal Oscillators & MEMS Oscillators**, half size &  
 full size (TTL/CMOS/HCMOS) with Stop and tri-state Function  
 Ceramic/Metal Package, **High Temperature** Range for **Automotive**  
**(AEC Q200 & AEC Q100)**, Tuning Fork Crystal, **SMD Programmable**  
**Oscillators**, Oscillators HCMOS-SMD-Pin Type Ceramic/Metal Package,  
**VCXO – TCXO – (VC)TCXO**-Clipped Sine-SMD, **PECL-SMD**, Oscillator-  
**LVDS-SMD**, **VCXO-PECL-SMD**, **Spread Spectrum** Oscillator-HCMOS-  
 SMD Ceramic/Metal Package, Customized Products.



**Lithium-Ion Batteries, Lithium Polymer Batteries, Lithium-Iron-  
 Phosphate Batteries**, NiMH Batteries, Lithium button cells, Cylindrical  
 Lithium Batteries, Lithium Thionyl Chloride Batteries, Battery Holders,  
 Lead Acid Batteries (VRLA), Alkaline Batteries, Hearing Aid Batteries,  
 Watch Batteries, **Customized Battery pack Design**.



**Rechargeable Lithium-Batteries**, Nickel Batteries, NiMH Batteries,  
 Lead Acid Batteries, No rechargeable Lithium Batteries, Battery holders,  
 Alkaline Batteries, Dry Batteries, Cylindrical Lithium batteries, Lithium  
 button cells, **Customized Battery Pack Design**.



**LED Lighting**, Flexible LED strips, Neon LED strips, LED RGB control &  
 RGB power amps, LED lighting drivers & power supplies, LED Modules,  
 Aluminum profiles, LED wall washers & LED bars, Fabricated optical fabrics,  
 Accessories for LED strips, **Customized Products**.



**RF Shielding Solutions:** Frame and Cover Shield, Drawn EMI/RF  
 Shields, Classic RF Shields, High Performance EMI/RFI Shields, Seamless  
 Protective Cages, Customized RF Shields.

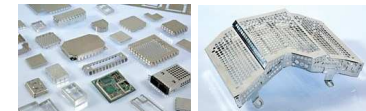

**High Reliability Sockets and Adapters:** Ball Grid Array Sockets and  
 Mini PGA Sockets, Carrier Sockets, Closed Frame DIP Sockets, DC/DC  
 Converter Sockets, Fuse Sockets, Image Sensor Sockets and Carrier  
 Sockets, Laminate Wafer Sockets (No Circuitry), LCC Sockets, LED  
 Sockets, Open Frame DIP Sockets, Optoelectronic Sockets, Pin Grid Array  
 Sockets and Adapters, PLCC Sockets, SIP Sockets, SMD Floating Terminal  
 Sockets, SMD Gull-Wing and "J" Lead Sockets, Tadiran Battery Sockets.



**High Performance IC Sockets and Adapters:** High Performance  
 Thermal Socket, Giga-snap, High Endurance GHz Socket, **Package**  
**Converters**, Electronic Module, Sockets, SMT Package Emulation,  
 Package Conversion, Probing Adapter, Prototyping Adapters, **Custom**  
**Engineered Products, Turn-Key solutions**.



**Test & Burn-in Sockets:** Clam Shell - Open Top & SMD Version,  
 SmartSocket, BGA / CSP: uBGA (CSP), PBGA, VFBGA, LGA, QFN: MLF,  
 MMC, BCC; Optical Transceivers, Gull Wing, SIP, Zig-Zag, Microwave &  
 Hybrid, LCC, PGA, Flat Pack, TO, Axial, Radial & MELF, DIP, PLCC / SOJ,  
 Connectors, Flexible Bus Boards, Universal Boards, Socket Savers,  
 Program Cards, **Customized Products**.



**Competence**  
**Quality**  
**Reliability**

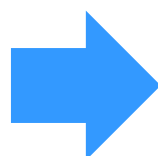

# Amphenol LTW

Innovation in Waterproof Solution



- CIRCULAR CONNECTORS
- POWER CONNECTORS
- M SERIES SENSOR CONNECTORS
- DISTRIBUTION BOXES
- USB CONNECTORS
- IEEE1394 CONNECTORS
- D-SUB CONNECTORS
- DVI CONNECTORS
- RJ CONNECTORS
- SSL SOLUTION CONNECTORS
- LED INDICATOR
- HDMI CONNECTORS
- SATA CONNECTORS
- FIBER OPTIC CONNECTORS
- NMEA 2000 CONNECTORS
- PV AC CONNECTORS / T-JUNCTION
- CABLE JOINER
- CABLE GLAND – ANTI-UV
- VENT CONNECTORS
- RBL CONNECTORS
- X-LOK CONNECTORS
- HS-LOK CONNECTORS
- CABLE ASSEMBLIES
- CUSTOM PRODUCTS



ISO14001



ISO 9001



CE



NMEA



UL



TUV



Intertek  
ETL



Complete Range of Waterproof Connectors & Cable Assembly



# Amphenol LTW

Innovation in Waterproof Solution

## Product Applications

Amphenol LTW supplies various waterproof solutions which could be met a wide variety of applications around the world. Here is the summary about Amphenol LTW product application for different industries and help you to search suitable products. If you need any detailed product information or technical support, please don't hesitate to contact with us.



# Amphenol LTW

Innovation in Waterproof Solution





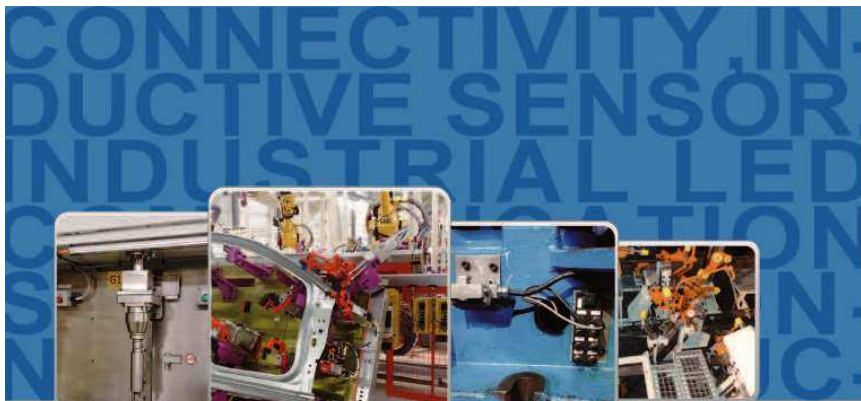

CONNECTIVITY  
INDUCTIVE SENSOR  
INDUSTRIAL LED  
COMMUNICATION SOLUTION



- Waterproof Interconnect Solutions
- M Series Connectors
- M5, M8, M12, M16, M17, M23, M40 Series Conn.s
- 7/8" Series Connectors
- Junction Box
- Splitter
- RJ45 Connectors
- Industrial Network Connectors
- DeviceNet
- Ethernet
- EtherNet-IP
- EtherCAT
- Profinet
- Profibus-DP
- Modbus TCP/IP
- CANopen
- CC-Link
- Valve Connectors
- Heavy Duty Connectors
- Industry Machine Light System
- Inductive Sensor
- Capacitive Sensor
- Industrial Relay
- Accessories
- Cable Assemblies
- Customized Products

**Quality Products - Innovative Solutions**

**Examples of Applications & Products**





# HOLIN<sup>®</sup>

*Solution of Waterproof Industrial Connectors*



## The Industrial Connectors Manufacture

For all weather & Harsh environments

Manufacturing IP66~IP68 Rated Connectors and Overmolded assemblies.

Providing Connector and Overmolded solutions Since 1997



**Waterproof Solutions:** Circular Connectors, M Series Connectors, NMEA 2000 Connectors, USB Connectors, RJ45 Connectors, HDMI Connectors, BNC Connectors, Hybrid Connectors, Cable Assemblies, CNC & Stamping Parts, Turn-Key Solutions, Customized Products

| QUALITY PRODUCTS • INNOVATIVE SOLUTION |





# HOLIN<sup>®</sup>

Solutions of Waterproof Industrial Connectors



## M Series Waterproof Sensor Connectors

General Information:  
 IP Rate: IP66 to 68  
 Number of Pins: 2 to 17 pins.  
 Current Rating: 0.5 to 5A  
 Connector Size: M5, M8, M12  
 Coding:  
 M5 > A coding  
 M8 > A, B and K coding.  
 M12 > A, B, C, D, K, L, M, P, S, T and X coding.



## Industrial I/O Waterproof Connectors

General Information:  
 IP Rate: IP66 to 68  
 Connector Type:  
 Ethernet RJ45  
 Mini USB B type  
 Micro USB  
 USB A type 2.0, 3.0  
 USB B type 2.0  
 HDMI A & C type  
 BNC



## Circular Waterproof Connectors

General Information:  
 IP Rate: IP66 to 68  
 Number of Pins: 2 to 37 pins.  
 Current Rating: 0.5 to 25A.  
 Temperature Range of Connector: -40°C to +105°C.  
 Mating Type: Screw Type or Lock Type.  
 Contact Resistance:  $\leq 10\text{m}\Omega$ .  
 Insulation Resistance:  $\geq 100\text{M}\Omega$  at DC500V.  
 Breakdown Voltage:  $\geq \text{AC } 1,000\text{V} / 1 \text{ minute.}$



## Product Assembly



## CNC & Stamping Customized Parts



## Custom Cable Assembly & Molding



The Industrial Connectors Manufacture







- Circular Connectors SF Series (SF6-SF8-SF10-SF12-SF16-SF20) IP67 shielded push-pull coupling
- Circular Connectors SA Series (SA10-SA12-SA16-SA20-SA28) IP67 shielded push-pull coupling
- Circular Connectors ST12 Series IP67 shielded threaded coupling
- Circular Connectors SP Series (SP11-SP13-SP17-SP21-SP29) IP68 Plastic threaded coupling
- Circular Connectors SY Series (SY13-SY17-SY21) IP67 Plastic bayonet coupling
- Circular Connectors WA22 Series IP67 threaded coupling
- Circular Connectors WAC3 Series IP65 bayonet coupling
- RJ45F – IP67 bayonet coupling
- Circular Connectors WP Series IP44 & IP55 bayonet coupling
- Circular Connectors WL Series IP67 threaded coupling
- Circular Connectors WD Series IP55 & IP65 threaded coupling
- Circular Connectors WS Series threaded coupling
- Circular Connectors WF Series IP44, IP55, IP67 threaded coupling
- Circular Connectors WY Series IP44, IP55, IP66, IP67 bayonet coupling
- Cable Gland – PG7, PG9, PG11, PG13.5, PG16, PG21, PG29, PG36
- Cable Assembly
- Accessories
- Custom Products



**WEIPU has a very wide product range, from 3A-200A, from 2pin – 61pin, from IP44-IP68. Our comprehensive series can meet most of requirements and harsh working environments.**

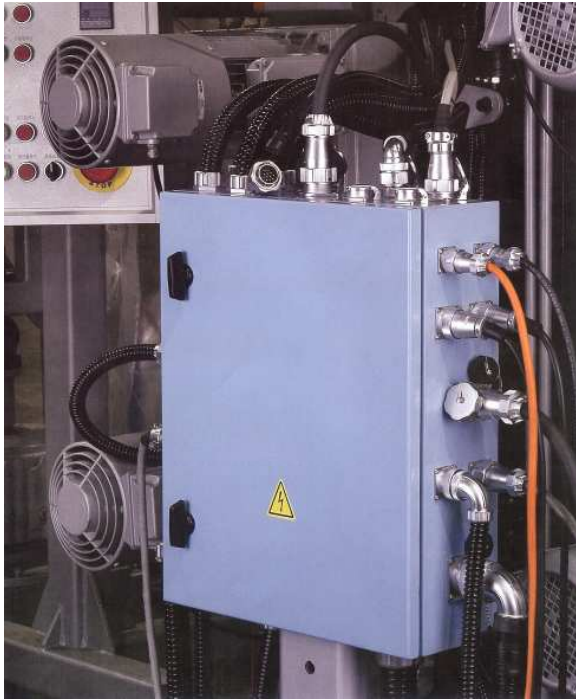

Architectural Lighting



Outdoor LED Display



Mining Lighting



Horticulture Lighting



Cruise and Shipyard Lighting



Commercial Lighting





**Board to Board Connectors**

- [Floating Connectors](#)
- [0.635mm Pitch Connectors](#)
- [1mm Pitch Connectors](#)



**Board to Board Connectors**

- [1.27mm Pitch Connectors](#)
- [Standard-Compliant Connectors](#)
- [Card Edge Connectors](#)



**Board to Cable Connectors**

- [Micro Coaxial Connectors](#)
- [Crimp Connectors](#)
- [Flat Cable Connectors](#)



**Interface Connectors**

- [Interface Connectors](#)



**Socket & Switches**

- [IC Connectors](#)
- [Card Connectors](#)
- [Switches](#)



**Battery Connectors**

- [Terminal Block Connectors](#)
- [Battery Connectors](#)

- *Monitor Entertainment*
- *Image Processing*
- *DLP Projector*
- *NotePC Entertainment*
- *Car Navigation Entertainment*
- *Communications*
- *Wimax ODU/IDU*
- *Test Equipments*
- *Motion Controls*
- *Multifunction Peripherals*
- *Gaming Machine*
- *Medical Machine*





## Catch Your Speed



# CATCH YOUR SPEED

Connectors and Cables



## CONNECTORS

QSFP Connector Series

SFP+ Connector Series

SFP Enhance Connector Series

Transformed SFP Conn. Series

SFP Connector Series

XFP Connector Series

InfiniBand Connector Series

CXP Connector Series

Micro D Connector Series

VHDCI Connector Series

SCSI II/III Connector Series

## CABLE ASSEMBLIES

Flat & Round Cable Assembly

Micro Coaxial Cable Assembly

# Product Applications



**Catch Your Speed**

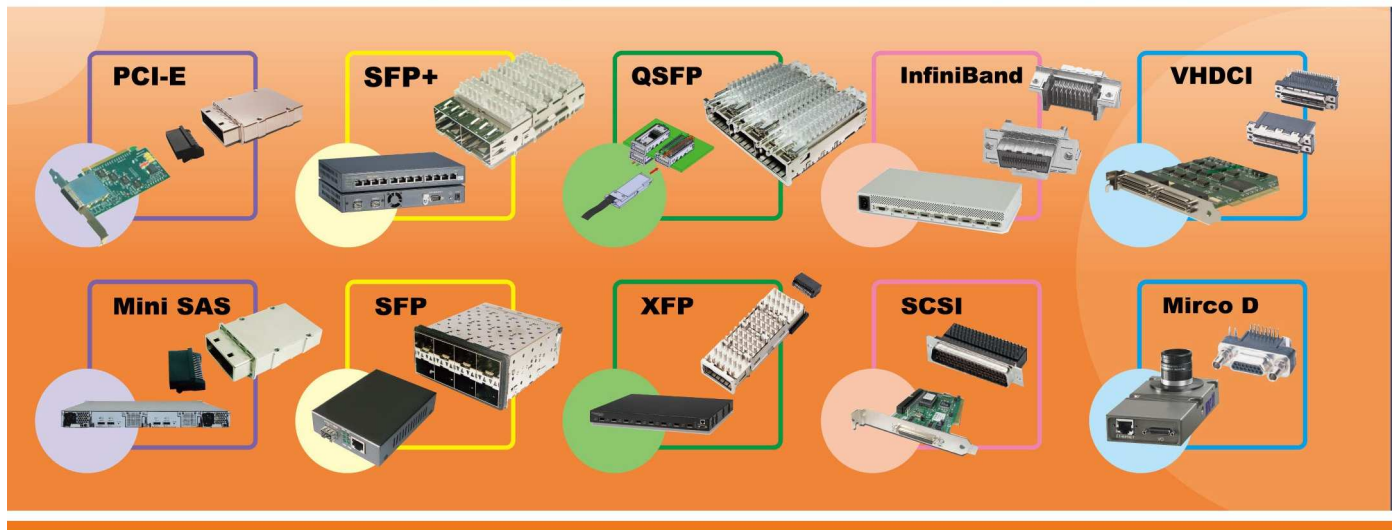

## HIGH - SPEED TEST INSTRUMENTS

### Good Signal Fidelity: Meeting The Demand of High-speed Application

All Best promises its customers the highest performance products in the most excellent manner. This continual focus on testing insures that its products have the excellent quality and high standards that customers expect.

The company has integrated its high-speed test instruments to meet customer demands. To do this, All Best has invested heavily into its high-speed test methodology process and uses customer feedback to continually improve its performance of connectors and cable assemblies.

Since its beginning, All Best's mission is to develop advanced connectors.

All Best is known for its creativity and R&D.

Its work is reflected in the many advanced products brought to market. In addition, All Best focuses continuously on improving technical performance. All Best also believes strongly in delivering superior customer service, increasing its capital and expanding its plant to meet its customers' needs.

All Best and its staff are committed to ensure superior product performance, enhance customer satisfaction and build on an already strong foundation of quality service.





**Specialist for Wire Harness and Connectors**

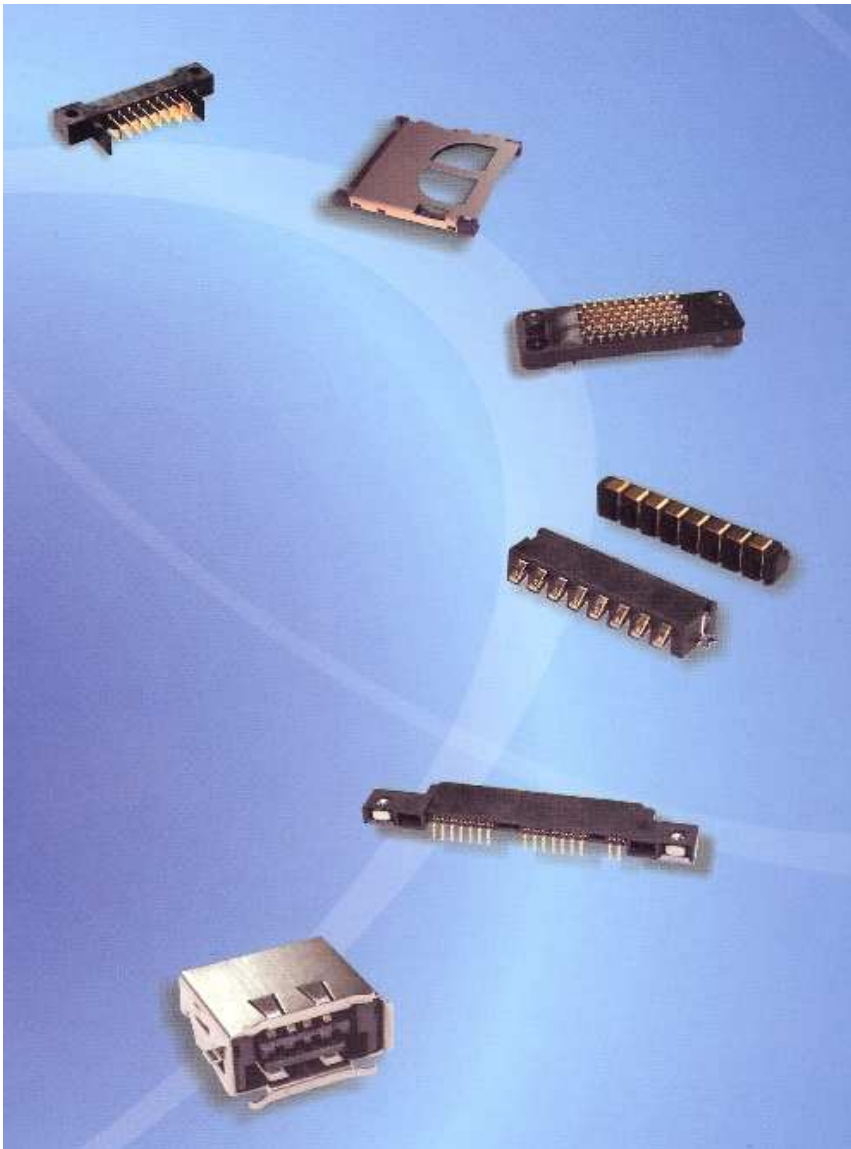

## Connectors

**Battery connectors**

**Pogo Pin connectors**

**Spring Loaded connectors**

**Spring Pin connectors**

**Board to Board connectors**

**Wire to Board connectors**

**Memory Card connectors**

**C.F. Card connectors**

**D-SUB connectors**

**Machine Pin Sockets**

**SATA connectors**

**USB connectors**

**Terminal Block**

## Cable Assembly

**Flat Cable & IDC Cable**

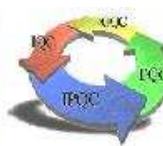

## Custom Products

**High Quality – Low Prices – Best Service – Timely Delivery**

*Market Application*

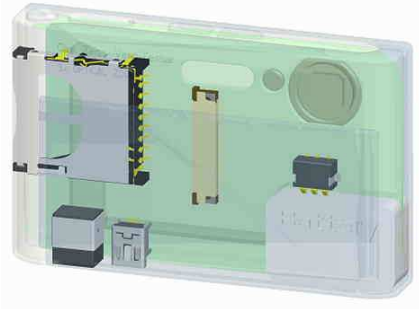





C.C.P.

# Creation Connection Perfectly

Pogo Pin Connectors

Spring Loaded Connectors

EV Crown Spring

Magnetic Solutions

Testing and Burn-in Solutions

ATE Connecting Solutions

Fine Pitch Connector Test

High Current Solutions

High Frequency Solutions

Customized Products

Quality Assurance



## Guaranteed Quality System

## Product Overview

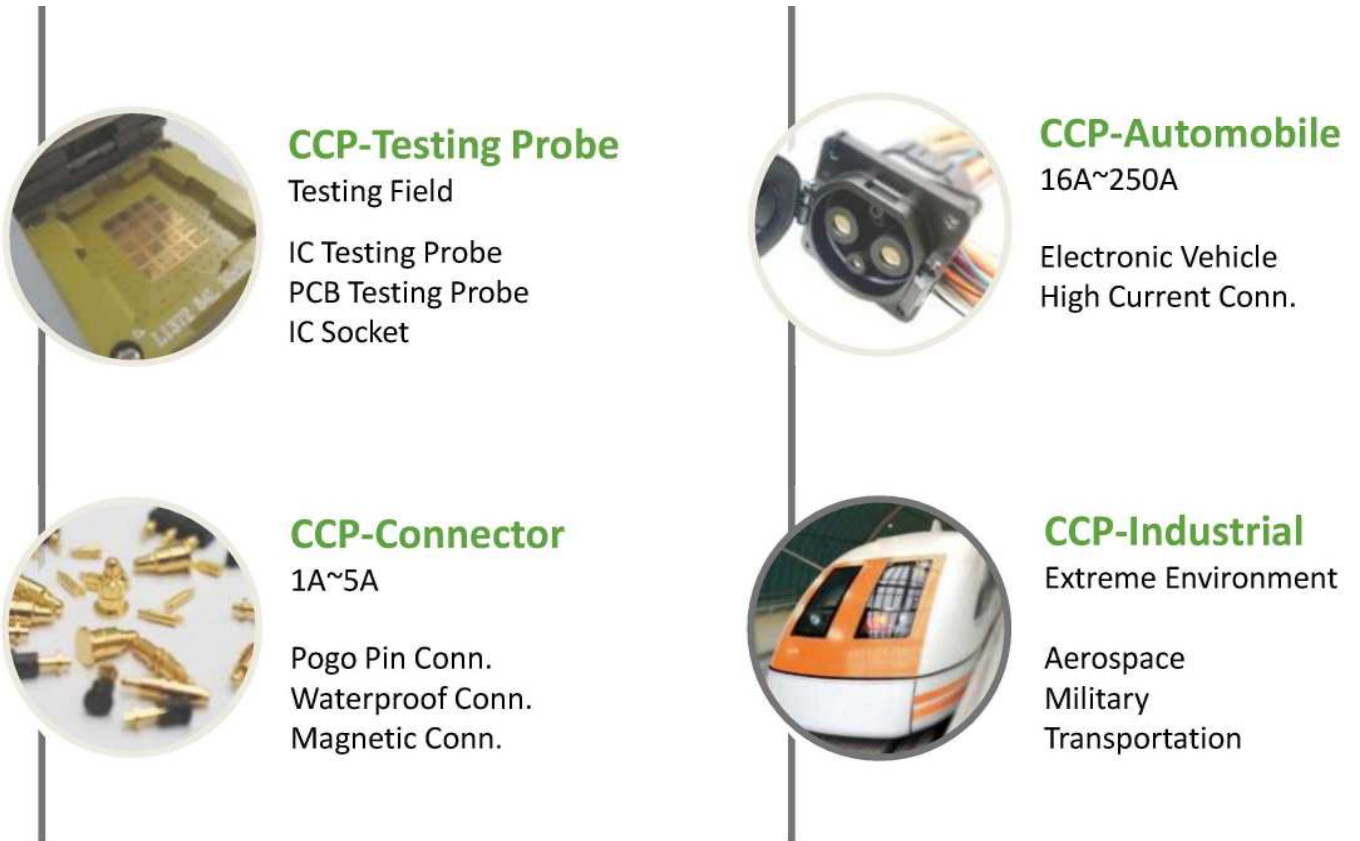

## CCP Guaranteed Quality System

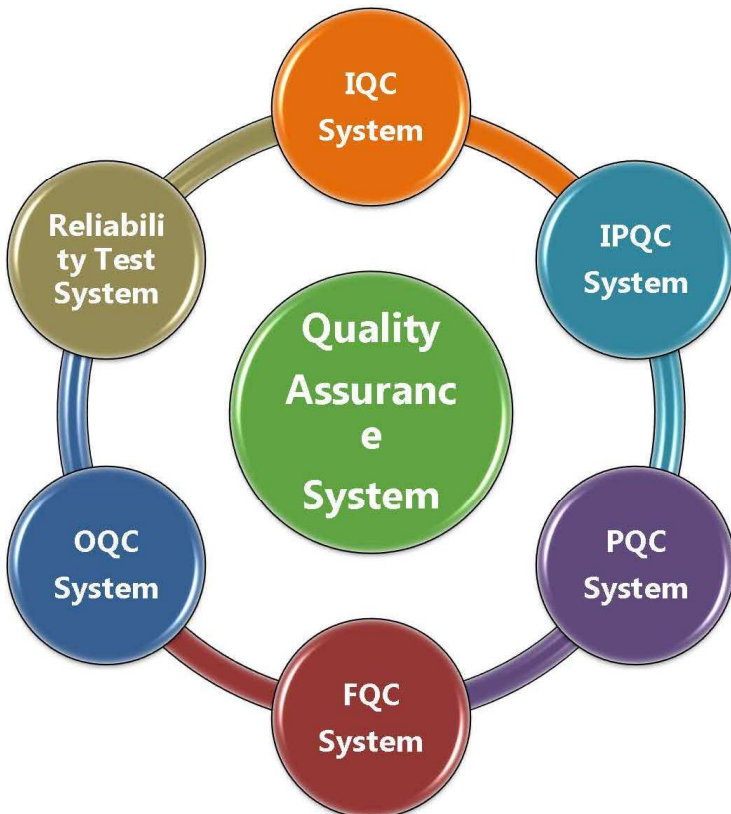

- Follow ISO and IECQ system.
- Integrate manufacture.
- Execute 100% AOI inspect. (Upon customer request)
- In-house lab to arrange reliability tests.



**ISO 9001**  
**ISO 14001**  
**ISO TS 16949**  
**ISO 14064**  
**IECQ QC080000**





ISO9000/14000/13485 • TS16949 • OHSAS18001 • IECQ QC080000



**Waterproof**



**Customized IO**



**High-Frequency**



- Turn-Key Solutions
- USB Hub
- USB Docking
- Wireless Charging
- Waterproof Conn.s
- M Series Connectors
- Push-Pull Connectors
- Automotive Conn.s
- Medical Conn.s
- OBD2 Solution
- USCAR Conn.s
- DisplayPortDongle
- DisplayPortAdaptor
- Pogo Magnetic Cable
- Device Charge Cable
- Cable Ass.y, Customized

# Simula solution provider

# Solution Overview

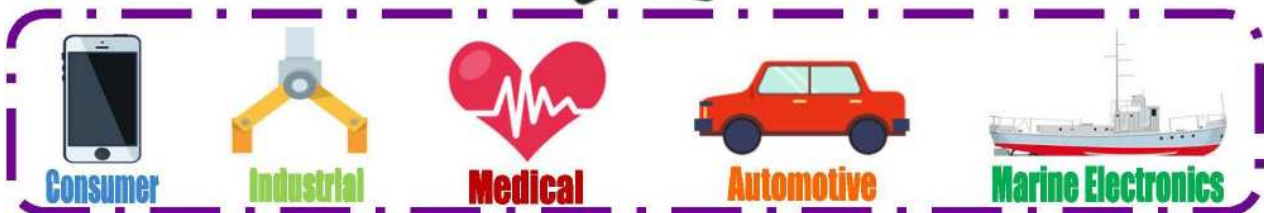
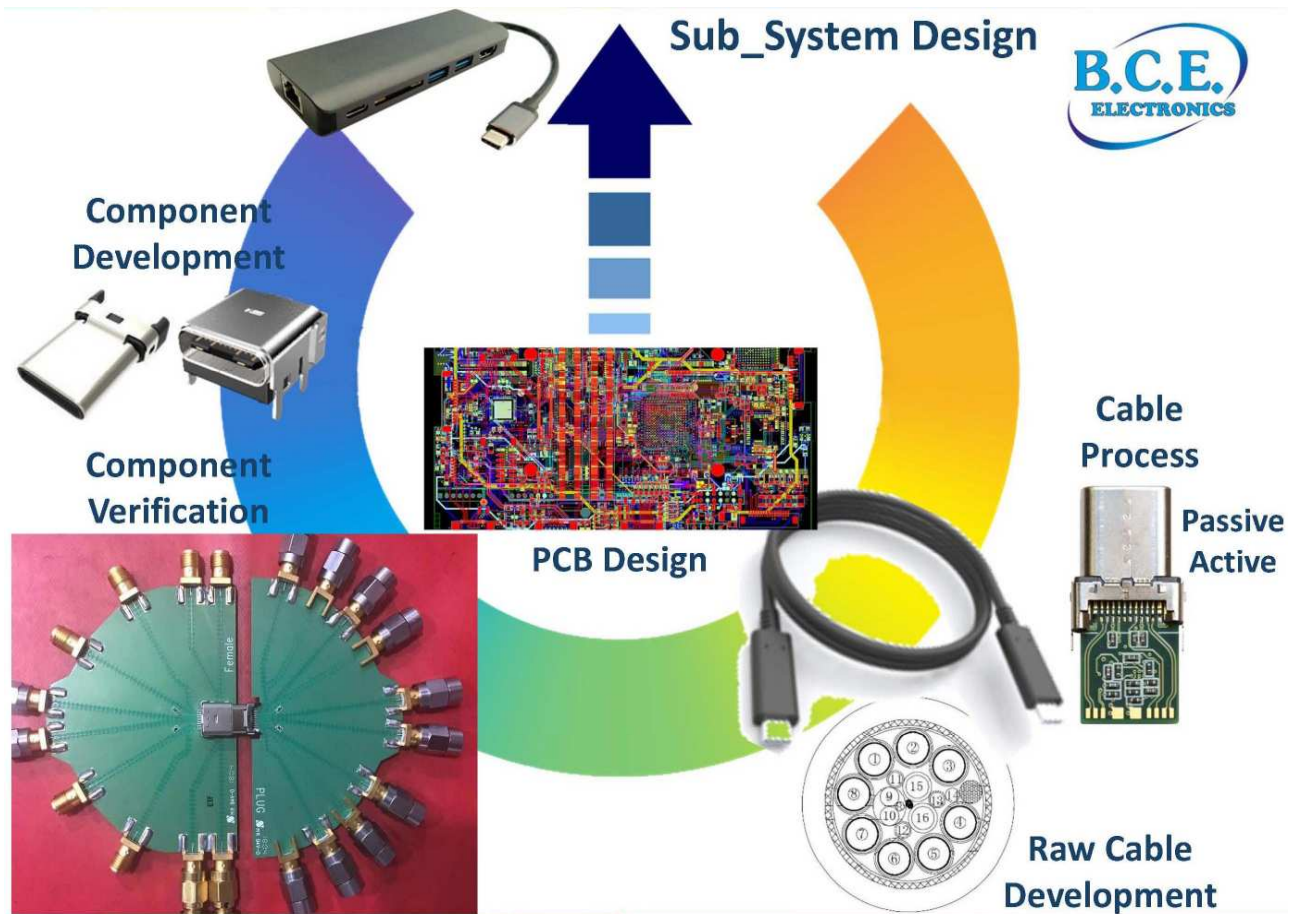



# Wire Harnesses



[www.bce.it](http://www.bce.it)

Flat Cable, USB & Connectors  
Serial ATA, Lcd & Telecom Assemblies

## Custom Cable Assembly:

- Wire Harnesses
- Round Cable
- Waterproof Cable
- USB & IEEE 1394
- Power Cord
- HDMI & DVI
- VGA & KVM
- Flat Cable
- SCSI Cable
- FPC / FFC Cable
- Micro Match Cable
- Sata Cable
- Coaxial Cable
- RF Cable
- LCD & Telecom Assemblies
- Waterproof Cable Assemblies
- Automotive Cable Assemblies

## Connectors:

- Board to Board
- Pin & Female Header
- Box Header
- Shrouded Header
- IC & PLCC Socket
- Wire to Board
- IDC Connector
- Micro Match Connector
- USB
- IEEE 1394
- HDMI / DVI / SCSI
- D-SUB & Hood
- FPC / FFC / Sata
- Terminals
- Switch / Mini Din
- DC Power Jack
- RCA Jack
- RJ45 Jack
- Earphone Jack
- Custom Products



Taiwantrade  
Supplier  
Business  
Information  
Verification



www.tuv.com  
ID 0000047106

- **Prototypes available**
- **Flexible order volume**
- **100% function testing**

Your best choice for Interconnection Solutions

# WIRE HARNESSSES

IP Camera Cable Assembly

Automotive Cable Assembly, LVDS Cable Assembly







## The Complete Solution

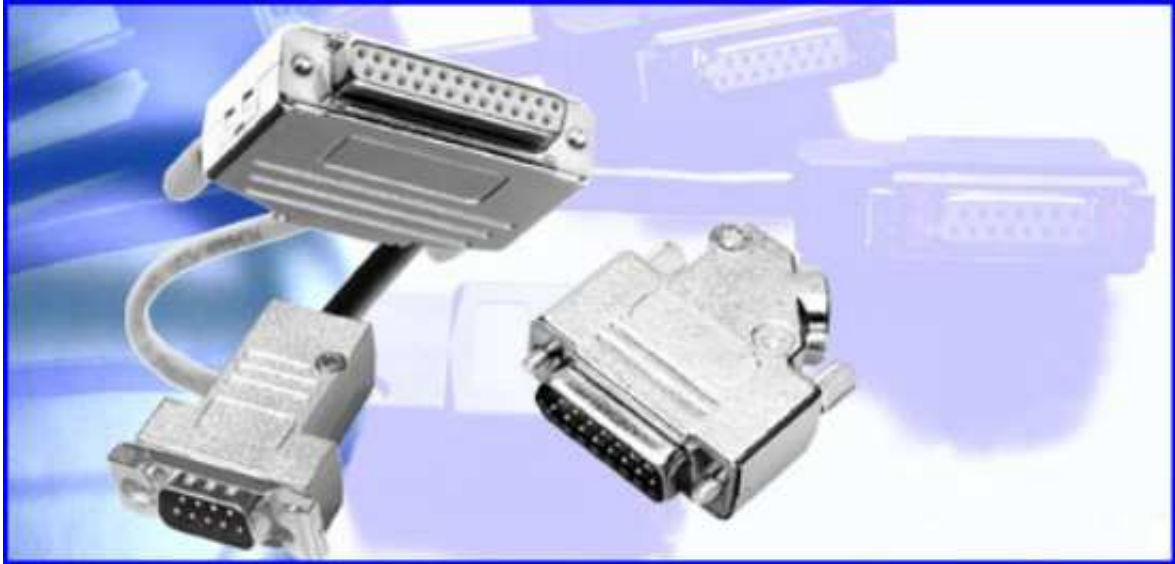

### HOODS

Metal Hoods

Metalized Plastic Hoods

Diecast Hoods

Metal + Plastic Hoods

Special Hoods

Adaptor Hoods

Accessories

### CONNECTORS

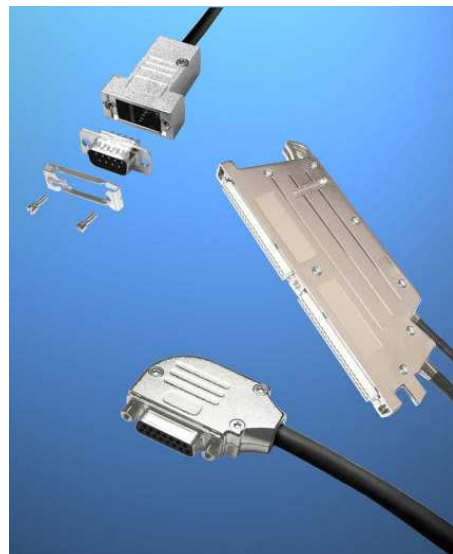

We look forward to being of service to you !!

# ABOUT US

MH Connectors is a leader in the design, worldwide manufacture and marketing of I/O interconnect products including our extensive ranges of connectors, hoods and covers. The site is designed to make it even easier to search our extensive product range, view technical data and find your local MH contacts and distribution partners.

Our manufacturing resources include an integrated facility capable of high volume throughout with precision moulding, stamping, plating and assembly. Tool design and maintenance are controlled by corporate staff. In addition, MH Connectors in-house hardware operation offers fast turn-around on connector hardware and custom packaging requirements. This coupled with our immensely experienced Engineering Group enable us to assist customers with full product development support from the initial concept stage through to a completed design including tooling, design validation and verification with samples, prototypes and pilot production.

## PRODUCT RANGE

Take a look at the ranges we have to offer...

HOODS & COVER



D-SUB CONNECTORS



MODULAR



ACCESSORIES



CUSTOM

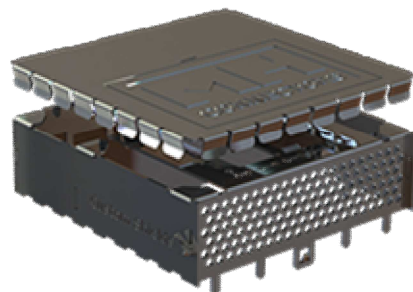



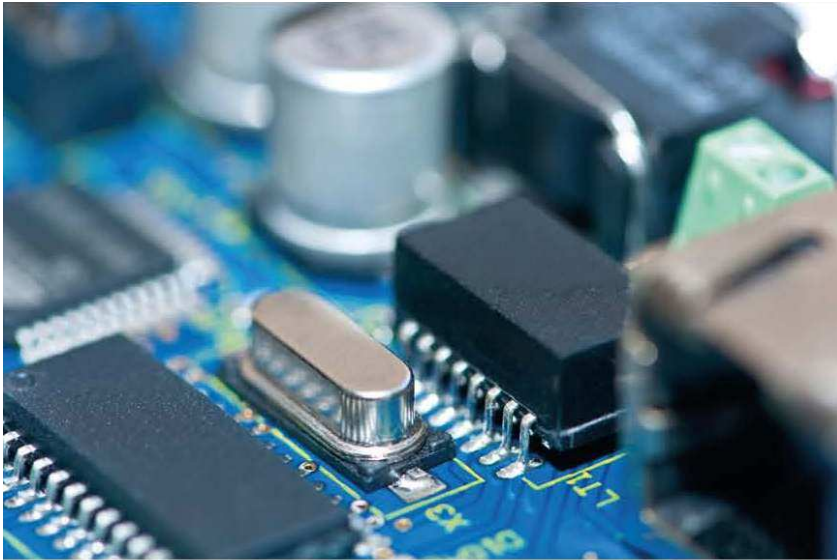

**▶ Quartz Crystals ◀**

- Quartz Crystal – SMD – Ceramic Package
- SMD – Metal/Ceramic Package
- SMD – Metal Package / Molded Base
- Pin Type – Metal Package
- Tuning Fork Crystal – SMD
- Tuning Fork Crystal – Pin Type

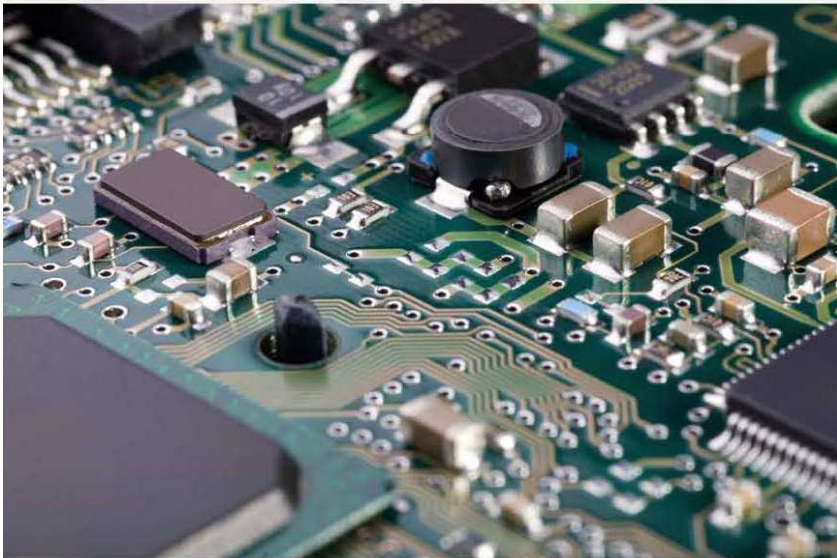

**▶ Quartz Crystal Oscillators ◀**

- HCMOS/LVPECL/LVDS/HCSL SMD – Ceramic/Metal Package
- Programmable – HCMOS – SMD – Ceramic Package
- HCMOS/LVPECL/LVDS – Pin Type – Full Metal Package
- VCXO - HCMOS/LVPECL/LVDS/HCSL SMD – Ceramic/Metal Package
- (VC)TCXO – Clipped Sine HCMOS/LVPECL/ LVDS – SMD Ceramic/Metal Package
- (VC)TCXO – Clipped Sine/ HCMOS/LVPECL/ LVDS – Pin Type Full Metal Package
- Spread Spectrum Oscillator – HCMOS-SMD Ceramic/Metal
- OCXO – SMD & Pin Type



**▶ MEMS Oscillators ◀**

- MEMS Oscillators

**TOTAL QUALITY ASSURANCE**

**▶ Custom Products ◀**

## Market Application



**Industrial Automation**



**Broadband Wireless Access**



**Smart Grids / Advanced Metering Infrastructure (AMI)**



**IP Closed-circuit Television (IP CCTV) & Security**



**Medical Devices**



**MRT / Railway**



**Testing and Measurement Equipment**



**Commercial Military Devices**



**SPA Controller**





### Quartz Crystals

- Quartz Crystal - SMD - Ceramic Package
- SMD – Metal / Ceramic Package
- SMD - Metal Package / Molded Base
- SMD - Plastic Mold Package
- Pin Type - Metal Package
- Tuning Fork Crystal – SMD
- Tuning Fork Crystal – Pin Type
- Automotive Quartz Crystal

### Quartz Crystal Oscillators

- HCMOS - SMD - Ceramic Package
- Programmable - HCMOS - SMD - Ceramic Package
- HCMOS - SMD - Ceramic / Metal Package
- HCMOS - Pin Type - Full Metal Package
- VCXO - HCMOS - SMD - Ceramic / Metal Package
- VCXO - HCMOS – Pin Type - Full Metal Package
- (VC) TCXO – Clipped Sine - SMD Ceramic / Metal Package
- PECL - SMD – Ceramic / Metal Package
- LVDS - SMD – Ceramic / Metal Package
- VCXO - PECL - SMD Ceramic / Metal Package
- Spread Spectrum Oscillator - HCMOS -SMD Ceramic / Metal

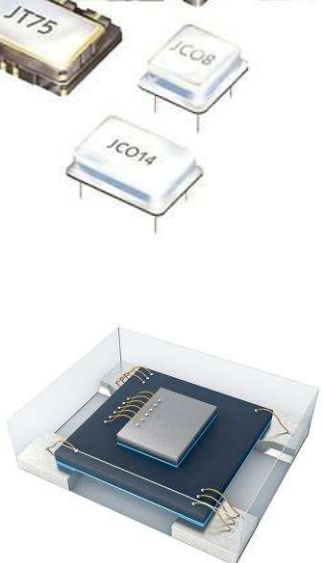

### MEMS Silicon Oscillators

# Measurably better

## Specialists for frequency Technology



Consumer Electronic



Automotive



Telecommunication



Medical Technology

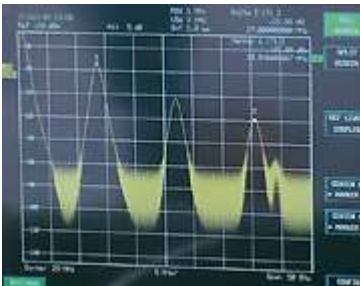

Measurement Instruments



Aerospace Industry



Industrial Applications



Electronic appliances of all kinds require one important element; the essential rhythm which enables appliances to adjust and function. Quartz crystal and oscillator components designed and manufactured by Jauch provide the most reliable pace-setters for modern electronics.

Jauch provides the most comprehensive range of structural elements for frequency control. Our high quality range extends from frequency control products for standard operating conditions to high-stability, shockproof components that are capable of operating under the most extreme conditions. Our products provide total reliability in the most demanding environments and fulfill the prerequisites of the most innovative high-tech applications.

The breadth and quality of our product range is the result of knowledge and experience built up over several decades. Jauch's own unique know-how concerning quartz provides the independence and flexibility which enables us to anticipate market changes and innovate to keep pace with developments in electronic appliances.

The world of Jauch provides a global vision where diversity and innovation bring people and ideas together. As a specialist for frequency control components, our products have a direct impact on peoples daily life. Our mission is to provide industry leading technology that makes life work better. Creating the essential rhythm required for all our technologically driven lives.

The Jauch Group is one of the leading specialists for quartz crystals, crystal oscillators and battery technology. Established in 1954, we are now one of the leading companies in the frequency control products industry, and most recently also with innovative MEMS timing clocks. We are a recognized expert on the future market for lithium ion and lithium polymer batteries.





**The specialists for batteries since 1976**

Innovation – Quality – Capability



**High Quality - Safe Performance**

## Products

- Lithium-Polymer Batteries
- Lithium-Ion Batteries
- Lithium-Iron-Phosphatate
- NiMH Batteries
- Lithium Thionyl Chloride
- Lithium button cells
- Lithium Batteries
- Battery holder
- Alkaline Batteries
- VLRA Batteries
- Silver Oxide Batteries
- Zinc-air Batteries
- Charging devices
- Battery Protection Circuits
- Customized Battery Packs



**Perfect Power for your application**

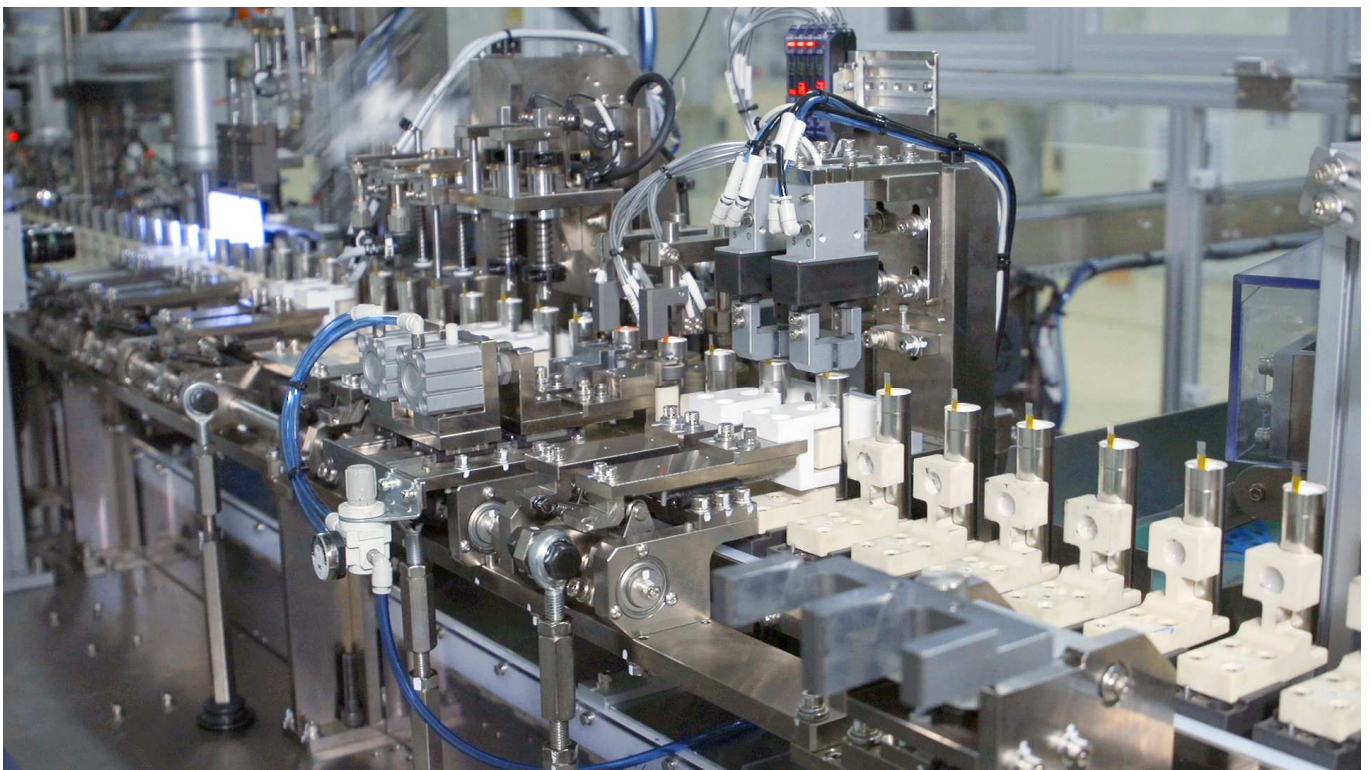
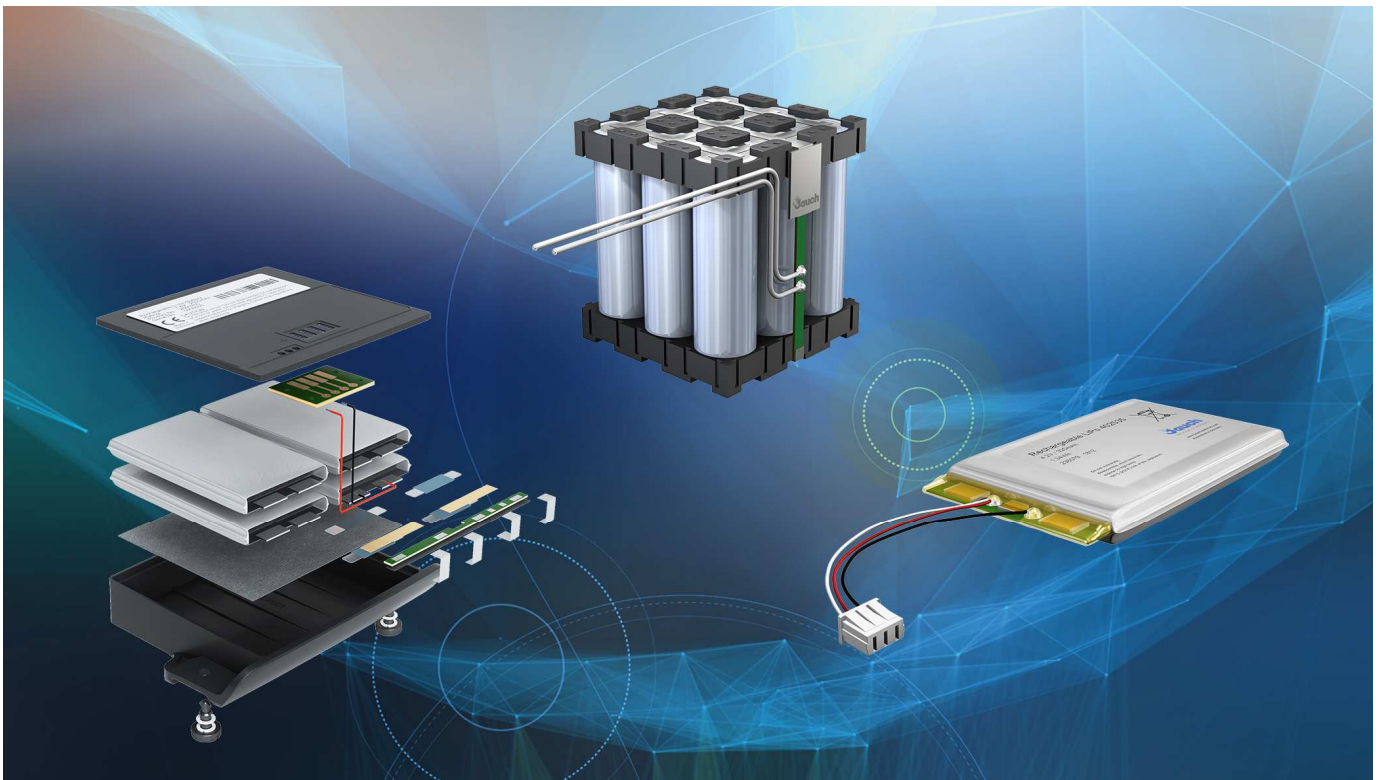

Customized pack design for your application:  
From cell selection, safety electronics right through to the  
assembly of the battery pack!

**Jauch Battery Solutions**



**Products**

• **Rechargeable Lithium-Batteries**

- 1) Li-Ion and Lithium Titanate batteries
- 2) Li-Po batteries
- 3) LiFePo4 batteries

• **Nickel Batteries**

- 1. Ni-MH batteries
- 2. Ni-Cd batteries
- 3. Ni-Cd / Ni-MH batteries
- 4. Nickel battery packs

• **Lead Acid Batteries**

- 1) AGM batteries
- 2) Dryfit batteries

• **No rechargeable Lithium Batteries**

- 1) LiSOCL2 batteries
- 2) LiMnO2 batteries
- 3) Lithium cells packs

• **Battery holders**

- 1) D/R/UM1 size
- 2) C/R14/UM2 size
- 3) AA/R6/UM3 size
- 4) AAA/R3/UM4 size
- 5) N/R01/UM5 size
- 6) Safety battery holders
- 7) Battery holders for lithium button cells

• **Alkaline Batteries**

• **Dry Batteries**

• **Cylindrical Lithium batteries**

• **Lithium button cells**

• **Customized Battery Packs**

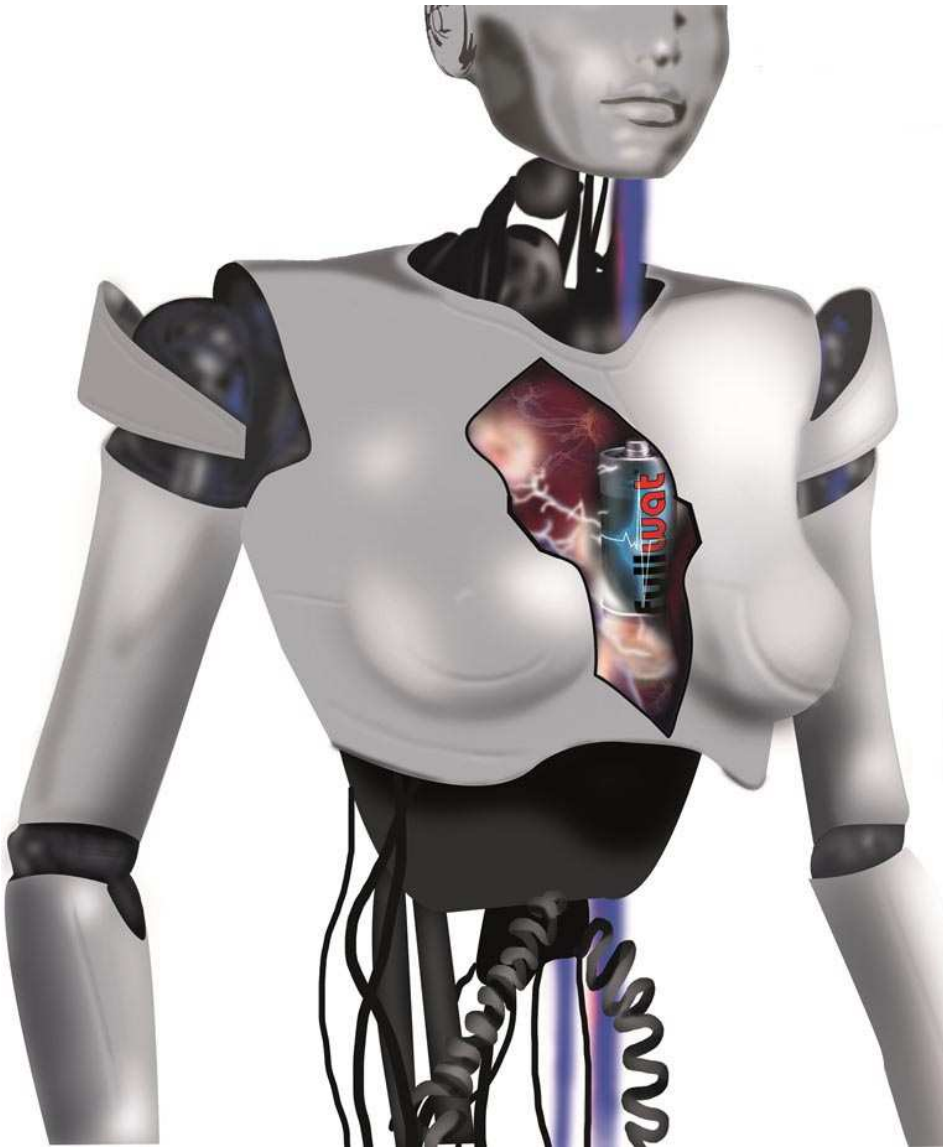

professional solutions

# fullwat®

su batería a medida  
full custom battery



Fabricamos la batería adecuada a sus necesidades  
We manufacture the right batteries for your own needs



# fullwat®

*Specialist for LED Lighting*



## Products

- Flexible LED strips
- Neon LED strips
- LED rgb control & rgb power amps
- LED lighting drivers and power supplies
- Aluminum profiles
- LED wall washers and LED bars
- LED modules
- Fabriled optical fabrics
- Accessories for LED strips



**LED Lighting Solutions**

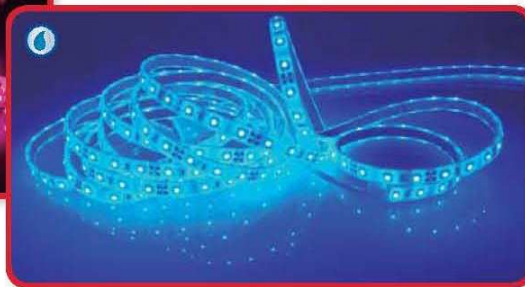

**IP20** Modelos no estancos Non waterproof models

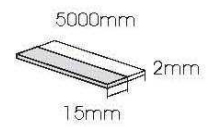

**IP67** Modelos estancos → referencias azules Waterproof models → blue references

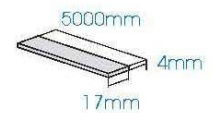

Sistema de estanqueidad  vaina de silicona. "Silicone tube"  waterproof system.

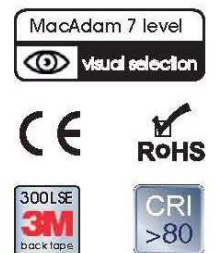





Save Time & Costs with largest selection available  
**STANDARD DRAWN EMI/RFI SHIELDS**

**Utmost Flexibility in EMI/RFI Design – The largest library in the electronics industry!**

**Fast and Economical Approach – Available instantly, Off-the-shelf!**

**High Performance – Seamless Protective EMI/RFI Cages!**

**Technology Area**

Automotive | Computer | Military | Data communications | General electronics | Medical equipment | Network equipment | Telecommunications | Any high-tech industry.

## **High Performance EMI/RFI Shields**

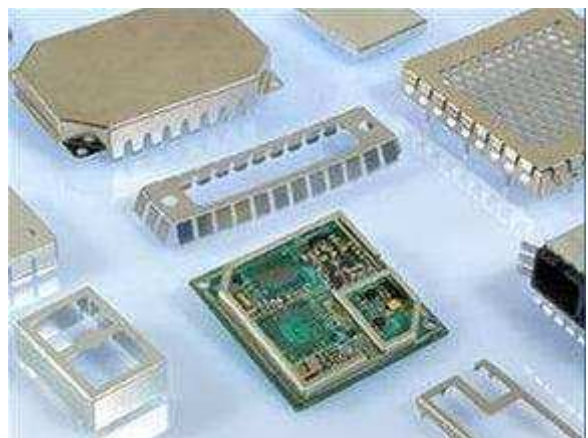
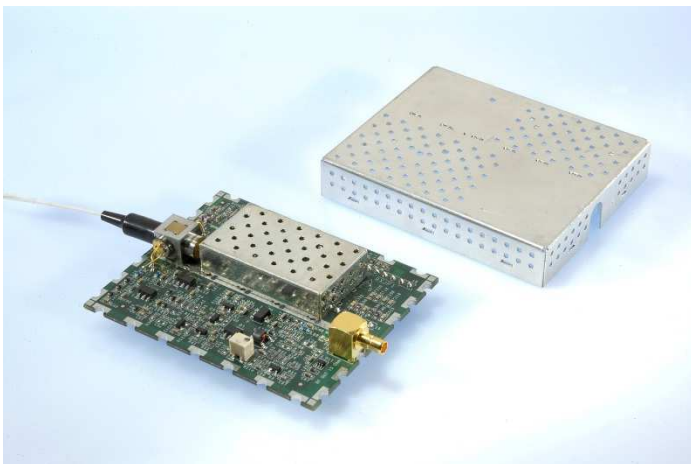
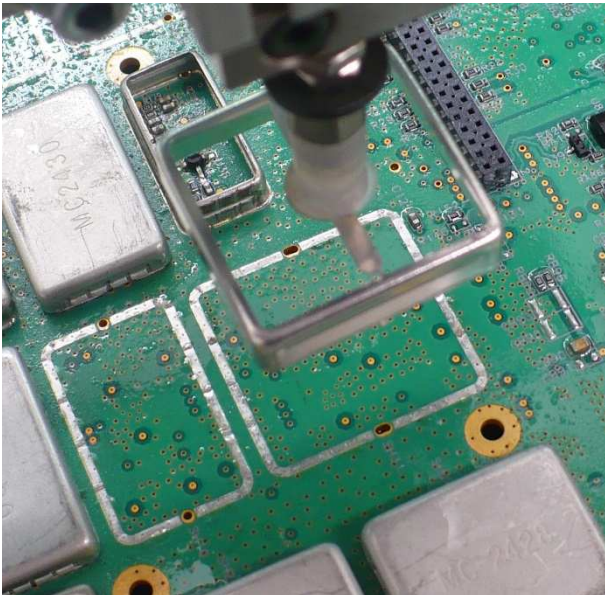
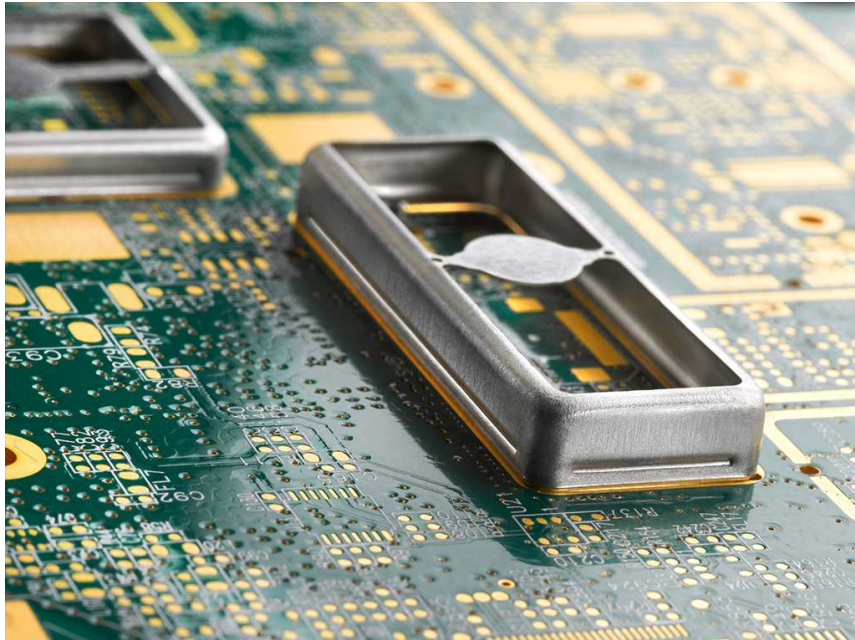

**Masach Tech specializes in board level EMI/RFI shielding design and production !!**



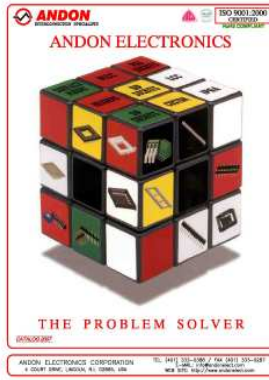
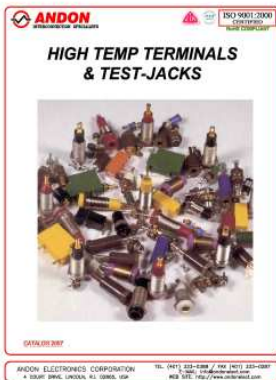

**Ball Grid Array Sockets and Mini PGA Sockets**

**Carrier Sockets**

**Closed Frame DIP Sockets**

**DC/DC Converter Sockets**

**Fuse Sockets**

**Image Sensor Sockets and Carrier Sockets**

**Laminate Wafer Sockets (No Circuitry)**

**LCC Sockets**

**LED Sockets**

**Open Frame DIP Sockets**

**Optoelectronic Sockets**

**Pin Grid Array Sockets and Adapters**

**PLCC Sockets**

**SIP Sockets**

**SMD Floating Terminal Sockets**

**SMD Gull-Wing and "J" Lead Sockets**

**Tadiran Battery Sockets**



**RoHS Compliant**  
**ISO 9001**  
**Certified**

[www.andonelect.com](http://www.andonelect.com)

**High Reliability, Innovation and Product Improvement**

At Andon Electronics we provide interconnection components that help companies to cost effectively protect, assemble, test and replace their semiconductor devices.



- PGA SOCKETS & ADAPTERS
- BGA SOCKETS & ADAPTERS
- SMD SOCKETS & ADAPTERS
- DIP SOCKETS & ADAPTERS
- SIP SOCKETS & ADAPTERS
- FUSE SOCKETS
- TERMINALS AND TEST JACKS
- LCC SOCKETS
- PLCC SOCKETS
- IMAGE SENSOR SOCKETS
- GAS SENSOR SOCKETS
- OPTOELECTRONIC SOCKETS
- CARRIER SOCKETS
- BATTERY SOCKETS
- TEST SOCKETS
- POWER CONVERTER SOCKETS

We offer custom as well as our standard catalog items.

Our intention is to be your one stop for all of your interconnection requirements

Contact:



**B.C.E. s.r.l.**

Via Regina Pacis, 54/c - 41049 SASSUOLO (MO) Italy

Tel. +39 0536 811.616 r.a. - Fax +39 0536 811.500

www.bce.it - E-mail: bce@bce.it



©Copyright 2011 Andon Electronics Corporation. All Rights Reserved. This material is protected under US and other copyrights and may not be copied, sold, or redistributed in any form without written permission of Andon Electronics Corporation. Copyrights and trademarks are property of their respective companies. We reserve the right to change specifications without notice. Andon makes no warranty, expressed or implied, as to the suitability of the sockets for the intended purpose

**RoHS Compliant**  
Andon Proprietary Information  
All Product Line Card 2011

**ANDON ELECTRONICS CORPORATION**  
4 Court Drive, Lincoln RI 02865, United States of America





**Ironwood**  
ELECTRONICS



**High Performance**  
**Sockets & Adapters**

Solutions for Engineering Lab & Production Line

High PERFORMANCE IC  
Sockets AND Adapters

ELECTRONIC  
Module

HEAT-SINK  
Simulation

High ENDURANCE  
Socket

40 GHz BGA,  
LGA, OFN Socket

GIGA-SNAP

OFN SMT  
EMULATOR

IN-SOCKET  
PROBE

High Performance Thermal Socket

Giga-snap

High Endurance GHz Socket

Package Converter

Electronic Module

Sockets

SMT Package Emulation

Package Conversion

Probing

Adapter

Custom Engineered Products



**New Innovative Technologies**

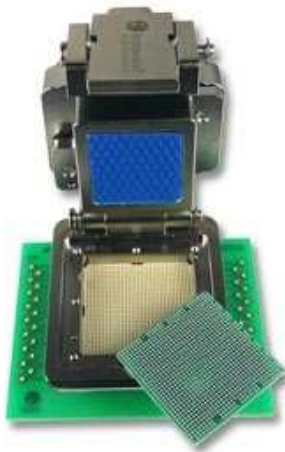
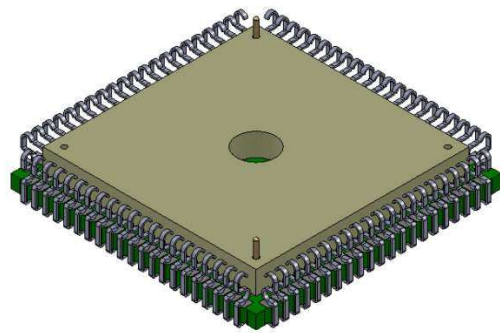
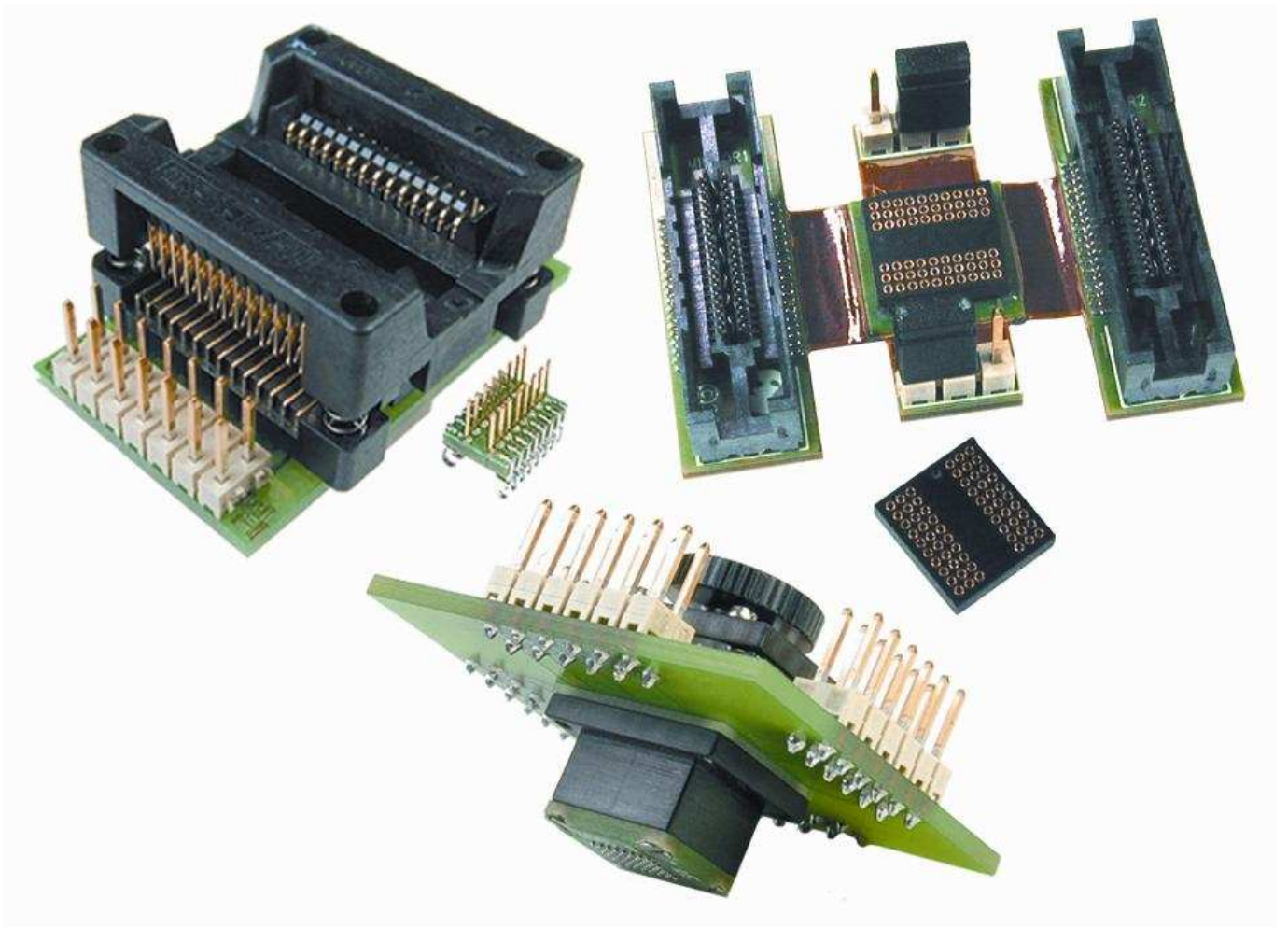



Products

- Smart Sockets
- BGA / CSP Sockets
- LGA
- QFN Sockets
- Optical Transceivers
- PGA
- Gull Wing Sockets
- SMD
- SIP
- Zig-Zag
- Microwave and Hybrid
- LCC w / Castellations
- FlatPack
- TO
- Axial / Radial / MELF
- DIP
- PLCC / SOJ
- Connectors
- Accessories
- Custom Products
- Burn - in Boards
- Burn – in Systems

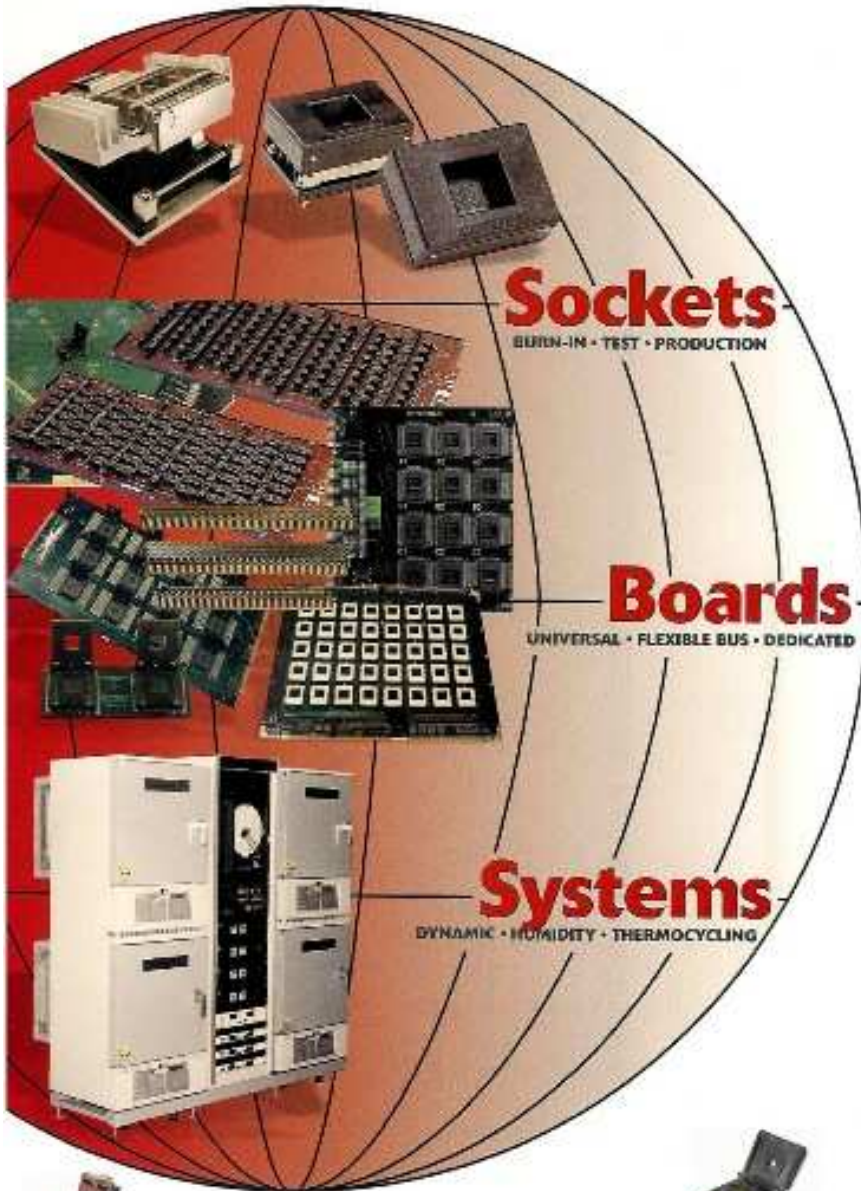

*Your Best choice for Test & Burn-in Solutions*



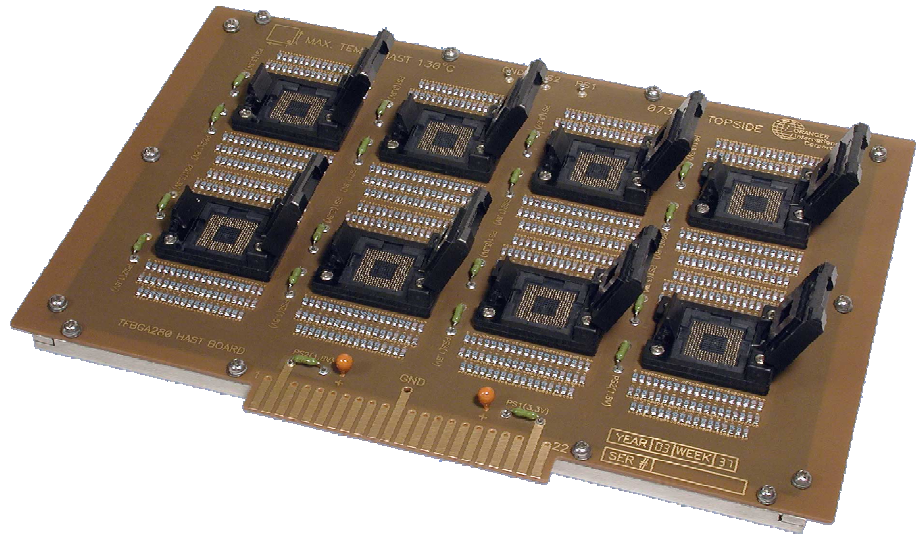
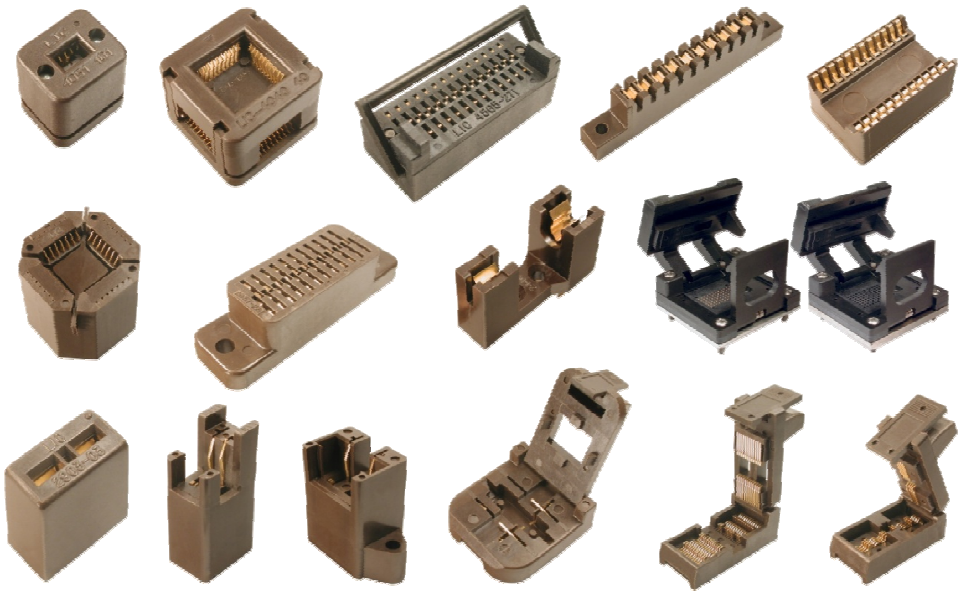
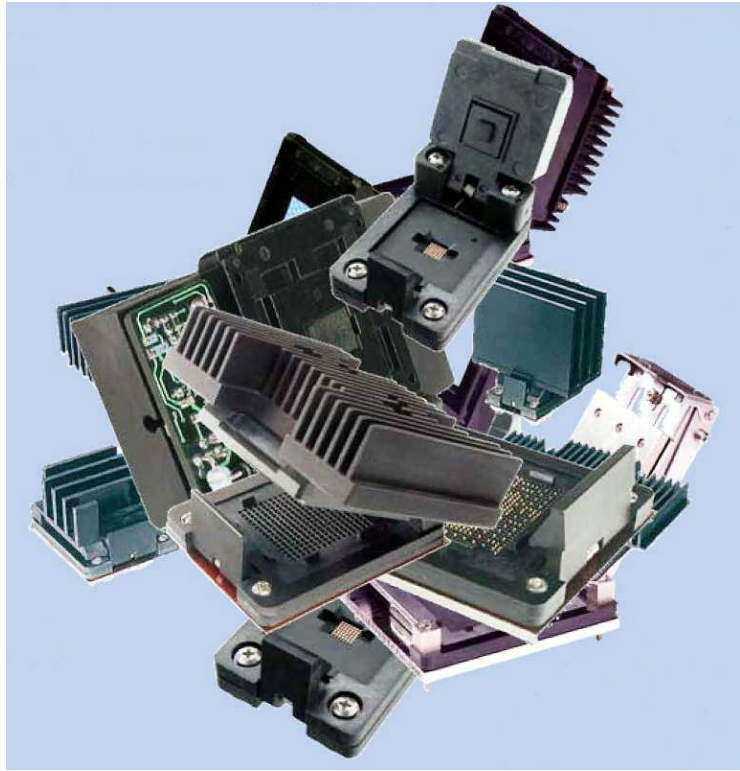



**Various Mold**

- Plastic injection & machinery components grinding work
- Die & Tooling development, design, and manufacturing OEM & ODM.
- Products include Zinc & Aluminum Alloy Die Casting, Stamping & Punching Mold & Tooling, Plastic Injection, etc.

Precise Device    Precise Manual Press    Precise Table Press  
 Press    Plastic Injection    Die Casting    CNC Precise Lathe Processing    Wax-Clean Modelling

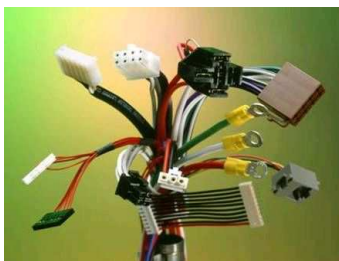



**B.C.E. s.r.l.**

Via Regina Pacis, 54/c - 41049 SASSUOLO (MO) Italy  
Tel. +39 0536 811.616 r.a. - Fax +39 0536 811.500  
[www.bce.it](http://www.bce.it) - E-mail: [bce@bce.it](mailto:bce@bce.it)

